

2 element Yagi 75 - 88 MHz

DESCRIPTION

- A 2-element VHF Yagi antenna for PMR/Trunked Radio, Broadcast and extended range VHF Aircraft Band applications.
- Produced to the highest quality standards
- These robust antenna designs will ensure reliable operation in harsh environmental conditions.
- Former Jaybeam brand product.



SPECIFICATIONS

Electrical	
Model	7031075
Frequency	75 - 88 MHz
Max. Input Power	150 W
Polarisation	Linear (Vertical or Horizontal)
3 dB Beamwidth, E-Plane	75 °
3 dB Beamwidth, H-Plane	150 °
Impedance	50 Ω
Gain	3 dBd (5.2 dBi)
VSWR	< 1.5:1
Front-To-Back Ratio	> 12 dB
Antistatic Protection	All metal parts DC-grounded (Connector shows a DC-short)
Mechanical	
Connection(s)	N(f) on 3m RG213/U cable
Materials	Boom, 32 mm dia. aluminium elements, 19.1 mm dia. aluminium balun, fully moulded enclosure
Length	Approx. 1350 mm / 53.15 in.
Wind Load	184 N (160 km/h)
Weight	Approx. 3.2 kg / 7.05 lb.
Mounting Bracket	3202078/68 + 3201079/00 (Ordered Separately)
Alternate Mounting Bracket	0900912/00, 0302032/68, or 0300064/00 + U-Bolts to match mounting pipe diameter (Ordered Separately)

ORDERING

Model	Product No.	Frequency
2 element Yagi	7031075	75 - 88 MHz
Accessories		
Galvanised steel crossover bracket 32/50 mm	0900912/00	
Pressed steel cross clamp 2" x 1-1/4" (JBL73)	0302032/68	
Cast aluminium cross clamp, circular	0300064/00	
M8 x 50 mm (2") U-Bolts (1 Pair)	4884036/00	
M8 x 75 mm (3") U-Bolts (1 Pair)	4884076/00	
Fixed norstel / coupler clamp (cross clamp)	3202078/68	
Increasing sleeve	3201079/00	

TYPICAL RADIATION PATTERN (E-PLANE - 82 MHZ)

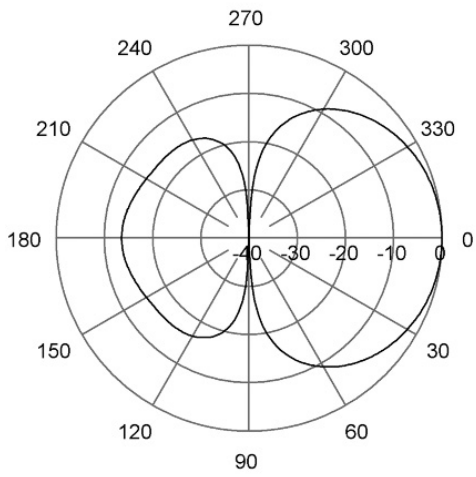

TYPICAL RADIATION PATTERN (H-PLANE - 82 MHZ)

